

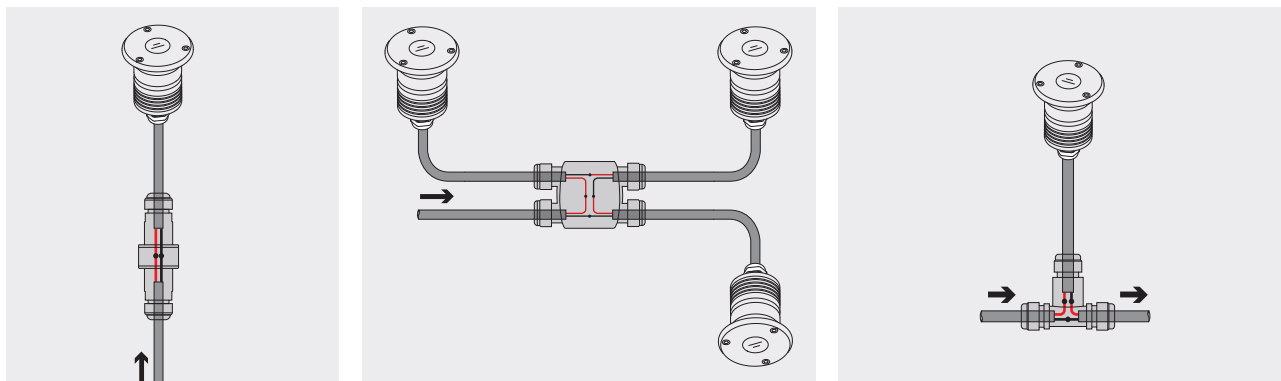









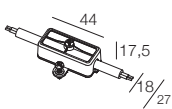

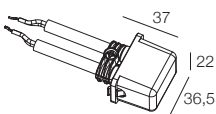

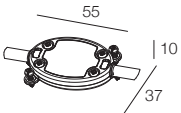

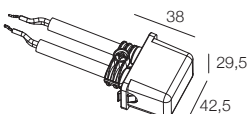
Connettori stagni IP68

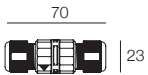

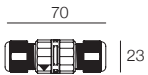

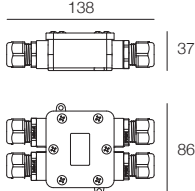





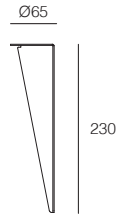

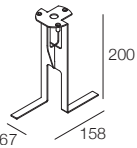
Watertight connectors IP68

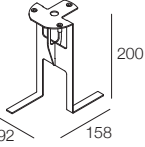

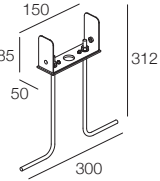
| | CODE | MATERIAL | DESCRIPTION |
|---|-----------|---------------------|--|
|   | A00357.40 | Plastico Plastic | Micro connettore stagno Micro watertight connector IP68 - CABLE Ø4,8 mm ÷ Ø6 mm Section 2x0,75 mm |
|   | A00387.40 | Plastico Plastic | Connettore stagno Watertight connector IP68 - CABLE Ø6 mm ÷ Ø8 mm Section 2x1 mm |
|   | A01023.40 | Plastico Plastic | Connettore stagno Watertight connector IP68 - CABLE Ø5 mm ÷ Ø7 mm Section 3x1 mm |
|   | A00388.40 | Plastico Plastic | Connettore stagno Watertight connector IP68 - CABLE Ø6mm ÷ Ø8 mm Section 3x1,5 mm |
|   | A01090.40 | Plastico Plastic | Mini connettore lineare IP68 2 poli 2 Poles mini linear connector IP68 Sezione del conduttore 0,25 mm ² - 2,5 mm ² Conductor cross section 0,25 mm ² - 2,5 mm ² Diametro esterno del cavo 7 mm - 12 mm Cable outer diameter 7 mm - 12 mm |
|   | A01091.40 | Plastico Plastic | Mini connettore lineare IP68 2 poli 2 Poles mini linear connector IP68 Sezione del conduttore 0,25 mm ² - 2,5 mm ² Conductor cross section 0,25 mm ² - 2,5 mm ² Diametro esterno del cavo 5,5 mm - 7 mm Cable outer diameter 5,5 mm - 7mm |
|   | A01089.40 | Plastico Plastic | Scatola di derivazione IP68 Junction box IP68 |
|   | A00155.40 | Plastico Plastic | Connettore "T" IP68 3 poli IP68 "T" connector 3 poles Sezione del conduttore 0,5 mm ² - 4,0 mm ² Conductor cross section 0,5 mm ² - 4,0 mm ² Diametro esterno del cavo 6,0 mm - 13,5 mm Cable outer diameter 6,0 mm - 13,5 mm |

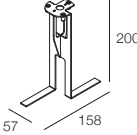
Picchetti e zanche

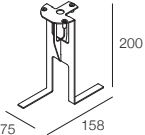
Stakes and anchors for concrete

| | | CODE | DESCRIPTION | USE WITH | |
|---|---|-----------|--|-----------------------------|---|
|  |  | A00852.60 | Picchetto in acciaio inox Stainless steel stake | MACRO H350 / H500 |  |
|  |  | A00943.60 | Zanche Anchor for concrete | | |
|  |  | A00870.60 | Zanche Anchor for concrete | TED SERIES |  |
|  |  | A00816.60 | Zanche Anchor for concrete | LUCIO |  |
|  |  | A00909.60 | Zanche Anchor for concrete | EDEN 6-8 |  |
|  |  | A00910.60 | Zanche Anchor for concrete | EDEN 12-18 |  |