





QUANTUM QF2+

-  IP40
-  Class III
-  Incasso a parete, soffitto
Wall, ceiling recessed
-  Installazione a filo
Trimless installation
-  Collegare in serie 350mA o 400mA o 500mA o 600mA o 700mA
Connect in series at 350mA or 400mA or 500mA or 600mA or 700mA
-  2100 gr
-  120x240 mm
-  Altamente riciclabile
Highly recyclable



QUANTUM CORE REFLECTOR

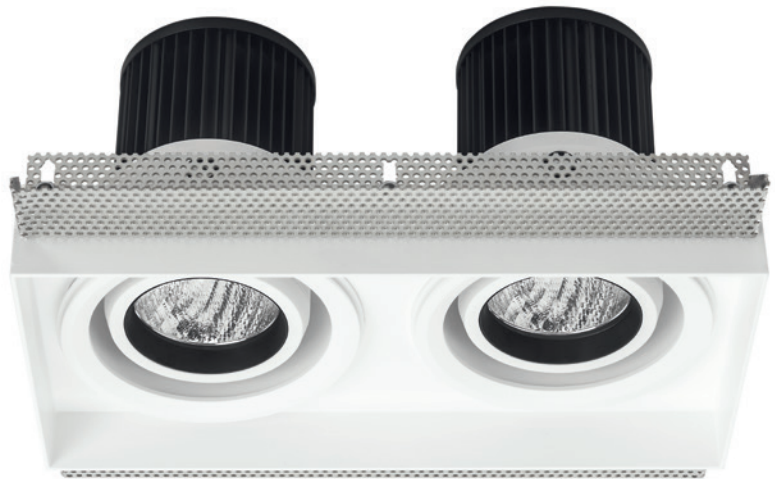

■ QUANTUM QF2+

Finiture
Finish

STRUTTURA
FRAME

A00395._ 0

Nell'ordine richiedere 1 Struttura
ogni 2 Moduli Quantum Q
Please specify in the purchase order
1 Frame each 2 Quantum Q Modules

- H Nero - Black
- 7 Bianco - White

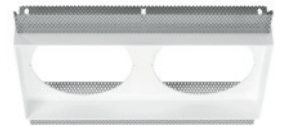

MODULO - MODULE
QUANTUM Q

14W
400mA

12W
350mA

18W
500mA

20W
600mA

25W
700mA

Finiture
Finish

Colore LED
LED Colour

Lumen Output 3000K

1650lm

1000lm at source

2000lm

1750lm at source

2700lm

10° Reflector

733917._ _

733763._ _

733771._ _

20° Reflector

783917._ _

783763._ _

783771._ _

30° Reflector

763917._ _

763763._ _

763771._ _

40° Reflector

743917._ _

743801._ T
DIM-TO-WARM

743763._ _

743955._ T
DIM-TO-WARM

743771._ _

- H Nero - Black
- 7 Bianco - White

- Y 2700K
- 6 3000K
- W 3000K CRI > 90
- 9 4000K
- Z 3250K BRILLIANT SPECIAL RETAIL
- T 3000K CRI > 90 DIM-TO-WARM

+

QUANTUM Q
x 2

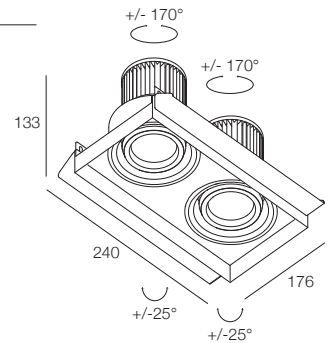

ALIMENTATORI CONSIGLIATI (non inclusi)
SUGGESTED DRIVERS (not included)

- 350mA CC20-A-350-N
- 400mA CC20-F-400-N
- 500mA CC20-F-500-N
- 600mA CC36-A-600-N
- 700mA CC20-F-700-N

ACCESSORI
ACCESSORIES



Nido D'ape
Hex Louver
A00362.40



Filtro Correttivo
Softening Lens
A00364.80

EXAMPLE CODE COMPOSITION
123456.

