







NEOS Q2

-  IP40
-  Class III
-  Incasso a parete, soffitto
Wall, ceiling recessed
-  Collegare in serie 300mA o 350mA
Connect in series at 300mA or 350mA
-  1600 gr
-  128x245 mm
-  Altamente riciclabile
Highly recyclable





NEOS Q2

STRUTTURA FRAME	A00532._ 0	Nell'ordine richiedere 1 Struttura ogni 2 Moduli Neos Q Please specify in the purchase order 1 Frame each 2 Neos Q Modules	Finiture Finish
			<ul style="list-style-type: none"> <input type="checkbox"/> H Nero - Black <input type="checkbox"/> 7 Bianco - White



MODULO - MODULE NEOS Q	10W 300mA	12W 350mA	Finiture Finish	Colore LED LED Colour
Lumen Output 3000K	1200lm	1000lm at source		

 20° Lens	783786._ _		<ul style="list-style-type: none"> <input type="checkbox"/> H Nero - Black <input type="checkbox"/> 7 Bianco - White 	<ul style="list-style-type: none"> <input type="checkbox"/> Y 2700K <input type="checkbox"/> 6 3000K <input type="checkbox"/> W 3000K CRI > 90 <input type="checkbox"/> 9 4000K <input type="checkbox"/> T 3000K CRI > 90 DIM-TO-WARM
 40° Reflector	723786._ _	723965._ T DIM-TO-WARM		
 60° Reflector	753786._ _	753965._ T DIM-TO-WARM		

+
NEOS Q
x2

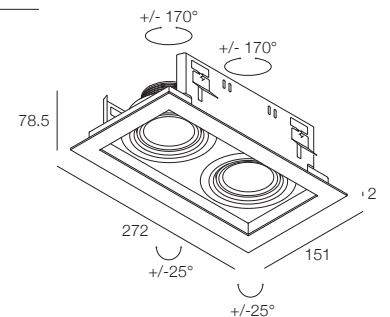

ALIMENTATORI CONSIGLIATI (non inclusi)
SUGGESTED DRIVERS (not included)

300mA	CC20-F-300-N
350mA	CC20-A-350-N

EXAMPLE CODE COMPOSITION
123456.

