

# Controcasse

## Recessed boxes









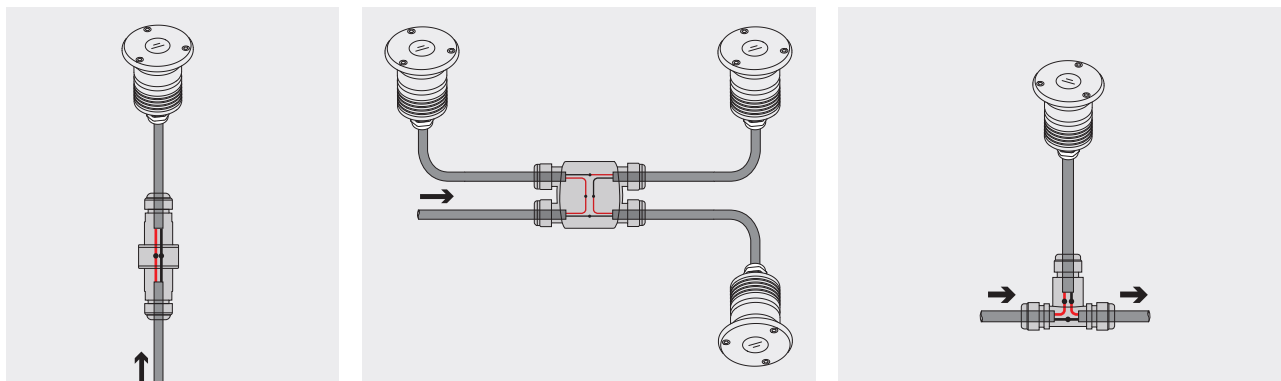

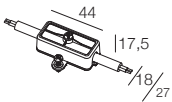

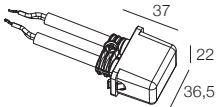

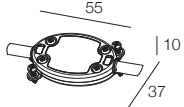
Installazione a parete o pavimento con parete nuda.  
Wall or ground installation, plain wall.

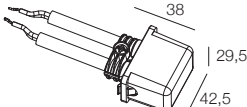
	CODE	MATERIAL	CUT-OUT	USE WITH	
	A00285.30	Alluminio Aluminum	 Ø 23 mm	<b>GEMMA 20 IP67</b>	
	A00285.40	Materiale plastico Plastic material		<b>GEMMA 20 IP68</b>	
	A00326.40	Materiale plastico Plastic material			
	A00161.30	Alluminio Aluminum	 Ø 40 mm	<b>GEMMA 35 IP67</b>	
	A00249.40	Materiale plastico Plastic material		<b>GEMMA 35 IP67 GS</b>	
	A00249.40	Materiale plastico Plastic material		<b>GEMMA Qd 35 IP67</b>	
				<b>LUI IP65</b>	
				<b>LEI IP65</b>	
	A00658.30	Alluminio Aluminum	 Ø 74 mm	<b>ASTRO 80</b>	
	A00129.30	Alluminio Aluminum	 Ø 50 mm	<b>ARCO 60 i</b>	
	A00250.40	Materiale plastico Plastic material		<b>ARCO 50 iL</b>	
	A00250.40	Materiale plastico Plastic material			
					
					

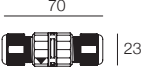
# Connettori stagni IP68

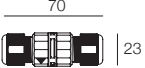
## Watertight connectors IP68

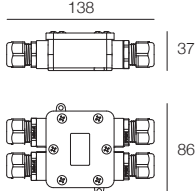

	CODE	MATERIAL	DESCRIPTION
 	A00357.40	Plastico Plastic	Micro connettore stagno Micro watertight connector IP68 - CABLE Ø4,8 mm ÷ Ø6 mm Section 2x0,75 mm
 	A00387.40	Plastico Plastic	Connettore stagno Watertight connector IP68 - CABLE Ø6 mm ÷ Ø8 mm Section 2x1 mm
 	A01023.40	Plastico Plastic	Connettore stagno Watertight connector IP68 - CABLE Ø5 mm ÷ Ø7 mm Section 3x1 mm
 	A00388.40	Plastico Plastic	Connettore stagno Watertight connector IP68 - CABLE Ø6mm ÷ Ø8 mm Section 3x1,5 mm
 	A01090.40	Plastico Plastic	Mini connettore lineare IP68 2 poli 2 Poles mini linear connector IP68 Sezione del conduttore 0,25 mm <sup>2</sup> - 2,5 mm <sup>2</sup> Conductor cross section 0,25 mm <sup>2</sup> - 2,5 mm <sup>2</sup> Diametro esterno del cavo 7 mm - 12 mm Cable outer diameter 7 mm - 12 mm
 	A01091.40	Plastico Plastic	Mini connettore lineare IP68 2 poli 2 Poles mini linear connector IP68 Sezione del conduttore 0,25 mm <sup>2</sup> - 2,5 mm <sup>2</sup> Conductor cross section 0,25 mm <sup>2</sup> - 2,5 mm <sup>2</sup> Diametro esterno del cavo 5,5 mm - 7 mm Cable outer diameter 5,5 mm - 7mm
 	A01089.40	Plastico Plastic	Scatola di derivazione IP68 Junction box IP68
 	A00155.40	Plastico Plastic	Connettore "T" IP68 3 poli IP68 "T" connector 3 poles Sezione del conduttore 0,5 mm <sup>2</sup> - 4,0 mm <sup>2</sup> Conductor cross section 0,5 mm <sup>2</sup> - 4,0 mm <sup>2</sup> Diametro esterno del cavo 6,0 mm - 13,5 mm Cable outer diameter 6,0 mm - 13,5 mm