

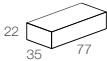









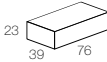

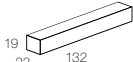







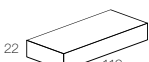











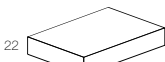

Alimentatori 500mA IP20













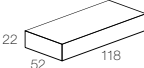





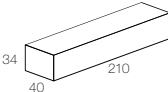













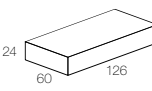





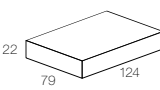









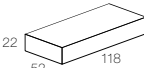







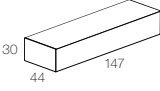



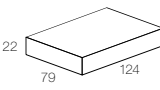

500mA LED driver IP20

■ NON DIMMERABILI NOT DIMMABLE

IP20	CODE	MIN - MAX LED	Vin	DIMENSIONS (mm)	CUT-OUT	CERTIFICATIONS
	CC6-F-500-N	1 - 3 LED 2W 1 LED 6W	@230Vac	 22 35 77	 Ø 42	
		1 - 3 LED 2W 1 LED 6W	@110Vac			
	CC10-F-500-NI	1 - 5 LED 2W 1 LED 6W 1 LED 9W	@230Vac	 23 39 76	 Ø 44	
		1 - 3 LED 2W 1 LED 6W	@110Vac			
	CC10-F-500-SI	1 - 6 LED 2W 1 LED 9W	@230Vac	 19 22 132	 Ø 28	
	CC14-F-500-S	1 - 7 LED 2W 1 - 2 LED 6W 1 LED 9W	@230Vac	 19 22 150	 Ø 32	   
		1 - 4 LED 2W 1 - 2 LED 6W	@110Vac			
	CC20-F-500-N	1 - 10 LED 2W 1 - 3 LED 6W 1 - 2 LED 9W 1 LED 18W	@230Vac	 22 52 119	 Ø 55	   
	CC20-F-500-NI	4 - 12 LED 2W 1 - 2 LED 9W 1 LED 18W	@230Vac	 23 38 125	 Ø 42	
	CC25-F-500-NT	7 - 12 LED 2W 2 - 4 LED 6W 1 - 2 LED 9W 1 LED 18W	@230Vac	 30 43 157	 Ø 53	   
	CC50-F-500-N	10 - 22 LED 2W 1 - 5 LED 6W 1 - 3 LED 9W 1 - 2 LED 18W	@230Vac	 22 79 124	 Ø 84	     
		10 - 22 LED 2W 1 - 5 LED 6W 1 - 3 LED 9W 1 - 2 LED 18W	@110Vac			

DIMMERABILI - MULTIFUNZIONE - PUSH - 1-10

DIMMABLE - MULTIFUNCTION - PUSH - 1-10

IP20	CODE	MIN - MAX LED	Vin	DIMENSIONS (mm)	CUT-OUT	CERTIFICATIONS
  	CC20-M-500-N	1 - 10 LED 2W 1 - 3 LED 6W 1 - 2 LED 9W 1 LED 18W	@230Vac	 22 52 118	 Ø 55	    EAC
		1 - 7 LED 2W 1 - 3 LED 6W 1 LED 9W 1 LED 18W	@110Vac			
	CC30-M-500-NL	1 - 15 LED 2W 1 - 4 LED 6W 1 - 3 LED 9W 1 LED 18W	@230Vac	 34 40 210	 Ø 54	  
		1 - 15 LED 2W 1 - 4 LED 6W 1 - 3 LED 9W 1 LED 18W	@110Vac			
  	CC32-M-500-N	1 - 14 LED 2W 1 - 4 LED 6W 1 - 2 LED 9W 1 LED 18W	@230Vac	 21 67 103	 Ø 72	   EAC
		1 - 8 LED 2W 1 - 2 LED 6W 1 LED 9W	@110Vac			
	CC40-M-500-NR	4 - 18 LED 2W 1 - 4 LED 6W 1 - 3 LED 9W 1 LED 18W	@230Vac	 24 60 126	 Ø 64	
		4 - 18 LED 2W 1 - 4 LED 6W 1 - 3 LED 9W 1 LED 18W	@110Vac			
  	CC50-M-500-N	10 - 22 LED 2W 1 - 5 LED 6W 1 - 3 LED 9W 1 - 2 LED 18W	@230Vac	 22 79 124	 Ø 84	    EAC 
		10 - 12 LED 2W 1 - 5 LED 6W 1 - 3 LED 9W 1 - 2 LED 18W	@110Vac			
   <small>DIM-TO-WARM</small>	CC20-A-500-N	2 - 10 LED 2W 1 - 3 LED 6W 1 - 2 LED 9W 1 LED 18W	@230Vac	 22 52 118	 Ø 72	    EAC 
		2 - 10 LED 2W 1 - 2 LED 6W 1 LED 9W	@110Vac			
  <small>DIM-TO-WARM</small>	CC36-A-500-N	4 - 14 LED 2W 1 - 4 LED 6W 1 - 2 LED 9W 1 LED 18W	@230Vac	 30 44 147	 Ø 54	   EAC 
   <small>DIM-TO-WARM</small>	CC50-A-500-N	10 - 22 LED 2W 1 - 5 LED 6W 1 - 3 LED 9W 1 - 2 LED 18W	@230Vac	 22 79 124	 Ø 84	    EAC  
		10 - 22 LED 2W 1 - 5 LED 6W 1 - 3 LED 9W 1 - 2 LED 18W	@110Vac			

POTENZIOMETRO
POTENTIOMETER

CODE
POT-M-REG-N













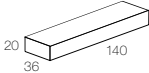

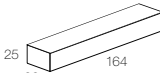



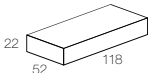





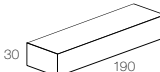





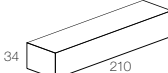







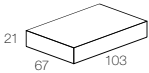





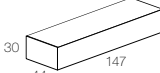





*Disponibile su richiesta
Available upon request

Alimentatori 500mA IP20

500mA LED driver IP20

DIMMERABILI - DALI

DIMMABLE - DALI

IP20	CODE	MIN - MAX LED	Vin	DIMENSIONS (mm)	CUT-OUT	CERTIFICATIONS
	CC10-D-500-NI	1 - 6 LED 2W 1 LED 6W 1 LED 9W	@230Vac	 20 140 36	 Ø 40	
	CC25-D-500-NI	1 - 15 LED 2W 1 - 4 LED 6W 1 - 2 LED 9W 1 LED 18W	@230Vac	 25 164 33	 Ø 44	
 	CC20-D-500-N	2 - 10 LED 2W 1 - 3 LED 6W 1 - 2 LED 9W 1 LED 18W	@230Vac	 22 118 52	 Ø 55	  *   * EAC
		2 - 8 LED 2W 1 - 2 LED 6W 1 LED 9W	@110Vac			
	CC20-D-500-NT	7 - 15 LED 2W 2 - 4 LED 6W 2 LED 9W 1 LED 18W	@230Vac	 30 190 43	 Ø 62	   EAC 
	CC30-D-500-NL	1 - 15 LED 2W 1 - 4 LED 6W 1 - 3 LED 9W 1 LED 18W	@230Vac	 34 210 40	 Ø 54	  *  
		1 - 15 LED 2W 1 - 4 LED 6W 1 - 3 LED 9W 1 LED 18W	@110Vac			
 	CC32-D-500-N	2 - 14 LED 2W 1 - 4 LED 6W 1 - 2 LED 9W 1 LED 18W	@230Vac	 21 103 67	 Ø 72	 
		2 - 10 LED 2W 1 - 2 LED 6W 1 LED 9W	@110Vac			
  	CC38-D-500-N	4 - 17 LED 2W 1 - 4 LED 6W 1 LED 18W	@230Vac	 30 147 44	 Ø 54	  * EAC 
   	CC50-D-500-N	10 - 22 LED 2W 1 - 5 LED 6W 1 - 3 LED 9W 1 - 2 LED 18W	@230Vac	 22 124 79	 Ø 84	    * EAC 
		10 - 22 LED 2W 1 - 5 LED 6W 1 - 3 LED 9W 1 - 2 LED 18W	@110Vac			

POTENZIOMETRO
POTENTIOMETER













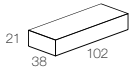

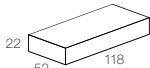

CODE
POT-M-REG-N



*Disponibile su richiesta
Available upon request

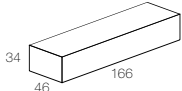









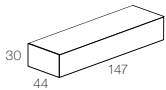

DIMMERABILI - TAGLIO DI FASE (IGBT - TRIAC)

DIMMABLE - PHASE CUT (IGBT - TRIAC)

IP20	CODE	MIN - MAX LED	Vin	DIMENSIONS (mm)	CUT-OUT	CERTIFICATIONS
   DIMA-TO-WARM	CC10-C-500-N	3 - 5 LED 2W 1 - 2 LED 6W 1 LED 9W	@230Vac	 21 38 102	 Ø 42	
  DIMA-TO-WARM	CC20-C-500-N	2 - 12 LED 2W 1 - 3 LED 6W 1 - 2 LED 9W 1 LED 18W	@230Vac	 22 52 118	 Ø 55	  EAC 
 	CC32-C-500-N	1 - 12 LED 2W 1 - 3 LED 6W 1 - 2 LED 9W 1 LED 18W	@230Vac	 34 46 166	 Ø 56	   * EAC

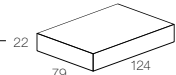





DIMMERABILI - CASAMBI INTEGRATO

DIMMABLE - CASAMBI INTEGRATED

IP20	CODE	MIN - MAX LED	Vin	DIMENSIONS (mm)	CUT-OUT	CERTIFICATIONS
 CASAMBI   DIMA-TO-WARM	CC38-B-500-N	4 - 16 LED 2W 1 - 4 LED 6W 1 - 2 LED 9W 1 LED 18W	@230Vac	 30 44 147	 Ø 54	EAC 
   DIMA-TO-WARM	CC60-B-500-N	10 - 22 LED 2W 1 - 5 LED 6W 1 - 3 LED 9W 1 - 2 LED 18W	@230Vac	 22 79 124	 Ø 84	 C  EAC  SELV 120V
		10 - 22 LED 2W 1 - 5 LED 6W 1 - 3 LED 9W 1 - 2 LED 18W	@110Vac			

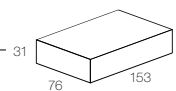

DIMMERABILI - DMX

DIMMABLE - DMX

IP20	CODE	MIN - MAX LED	Vin	DIMENSIONS (mm)	CUT-OUT	CERTIFICATIONS
 	CC50-X-500-NL	1 - 15 LED 2W 1 - 8 LED 6W 1 - 4 LED 9W 1 - 2 LED 18W 1 - 10 LED 3x2W RGB	@230Vac	 31 76 153	 Ø 84	 C  LISTED
		1 - 15 LED 2W 1 - 8 LED 6W 1 - 4 LED 9W 1 - 2 LED 18W 1 - 10 LED 3x2W RGB	@110Vac			

NON DIMMERABILI - FISSI - PER BATTERIA

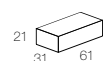





NOT DIMMABLE - FIXED - FOR BATTERY

IP20	CODE	MAX LED	Vin	DIMENSIONS (mm)	CUT-OUT	CERTIFICATIONS
	CC15-F-500-NB	1 - 3 LED 2W 1 LED 6W	12 Vdc	 21 31 61	 Ø 38	EAC 
		1 - 6 LED 2W 1 LED 6W 1 LED 9W	24 Vdc			
		1 - 12 LED 2W 1 - 3 LED 6W 1 - 2 LED 9W	48 Vdc			

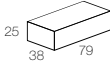

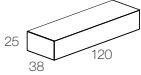
Alimentatori 500mA IP67

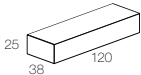
500mA LED driver IP67





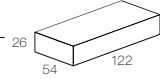



NON DIMMERABILI NOT DIMMABLE

IP67	CODE	MIN - MAX LED	Vin	DIMENSIONS (mm)	CUT-OUT	CERTIFICATIONS
	CC14-F-500-PI	1 - 9 LED 2W 1 - 2 LED 6W 1 LED 9W	@230Vac			
	CC20-F-500-PI	1 - 10 LED 2W 1 - 3 LED 6W 1 - 2 LED 9W 1 LED 18W	@230Vac			
	CC30-F-500-PI	9 - 18 LED 2W 3 - 4 LED 6W 2 - 3 LED 9W 1 LED 18W	@230Vac			

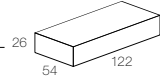

DIMMERABILI - MULTIFUNZIONE - PUSH - 1-10 DIMMABLE - MULTIFUNCTION - PUSH - 1-10

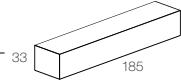
IP67	CODE	MIN - MAX LED	Vin	DIMENSIONS (mm)	CUT-OUT	CERTIFICATIONS
	CC20-M-500-P	1 - 10 LED 2W 1 - 3 LED 6W 1 - 2 LED 9W 1 LED 18W	@230Vac			
		1 - 8 LED 2W 1 - 2 LED 6W 1 LED 9W 1 LED 18W	@110Vac			

DIMMERABILI - DALI DIMMABLE - DALI

IP67	CODE	MIN - MAX LED	Vin	DIMENSIONS (mm)	CUT-OUT	CERTIFICATIONS
 	CC25-D-500-P	1 - 12 LED 2W 1 - 4 LED 6W 1 - 2 LED 9W 1 LED 18W	@230Vac			 
		1 - 8 LED 2W 1 - 2 LED 6W 1 LED 9W	@110Vac			
	CC55-D-500-PI	1 - 14 LED 2W 1 - 4 LED 6W 1 - 3 LED 9W 1 LED 18W	@230Vac			
		1 - 9 LED 2W 1 - 2 LED 6W 1 LED 9W	@110Vac			

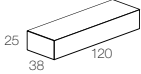
DIMMERABILI - TAGLIO DI FASE (IGBT - TRIAC) DIMMABLE - PHASE CUT (IGBT - TRIAC)

IP67	CODE	MIN - MAX LED	Vin	DIMENSIONS (mm)	CUT-OUT	CERTIFICATIONS
	CC25-C-500-PI	8 - 13 LED 2W 2 - 4 LED 6W 2 LED 9W 1 LED 18W	@230Vac			

POTENZIOMETRO
POTENTIOMETER

CODE
POT-M-REG-N

